





General Shale®

2026

OUTDOOR LIVING ITEMS LIST







All Products Priced per F.O.B. pickup
General Shale-Piney Flats, 909 Mountain View Drive,
Piney Flats, TN 37686~423-538-3332

Watson Town Clay Pavers







	Code	Size	Color	Pieces Per Package	Per Piece Weight	"Package Weight"
	6012002285	4"x2-1/4"x8"	SCARSDALE	470	5.75lbs	2702.5lbs
	6012002759	4"x2-1/4"x8"	TIDEWATER	470	5.75lbs	2702.5lbs
	6012001352	4"x2-1/4"x8"	GARDEN BLEND	470	5.75lbs	2702.5lbs
	6012000253	3-5/8"x1/4"x7-5/8"	ALVERTON	520	4.5lbs	2340lbs
	6012000395	3-5/8"x1/4"x7-5/8"	BERKS	520	4.5lbs	2340lbs

Weathered Wall Building Stones

Also available in non-weathered at special request. Contact your General Shale representative for details.



	Code	Size	Color	Pieces Per Package	Per Piece Weight	Package Weight
	6058027305	4"x4"x16"	WEATHERED NORMANDY	180	16 lbs	2880 lbs
	6058030072	4"x8"x8"	WEATHERED BUFF	180	17 lbs	3060 lbs
	6058022287	4"x8"x8"	WEATHERED NORMANDY	180	17 lbs	3060 lbs
	6058028105	4"x8"x12"	WEATHERED BUFF	120	25 lbs	3000lbs
	6058025990	4"x8"x12"	WEATHERED NORMANDY	120	25 lbs	3000lbs
	6058025813	4"x8"x16"	WEATHERED BUFF	90	32 lbs	2880 lbs
	6058025622	4"x8"x16"	WEATHERED NORMANDY	90	32 lbs	2880 lbs

Weathered Wall Cap Stones



	Code	Size	Color	Pieces Per Package	Per Piece Weight	Package Weight
	6058030071	4"x8"x8"	WEATHERED BUFF SINGLE ROUNDNOSE	180	17 lbs	3060 lbs
	6058022291	4"x8"x8"	WEATHERED NORMANDY SINGLE ROUNDNOSE	180	17 lbs	3060 lbs
	6058025904	4"x8"x14"	WEATHERED BUFF SINGLE ROUNDNOSE	90	30 lbs	2700 lbs
	6058025907	4"x8"x14"	WEATHERED NORMANDY SINGLE ROUNDNOSE	90	30 lbs	2700 lbs
	6058025917	4"x8"x16"	WEATHERED BUFF SINGLE ROUNDNOSE	90	32 lbs	2880 lbs
	6058025916	4"x8"x16"	WEATHERED NORMANDY SINGLE ROUNDNOSE	90	32 lbs	2880 lbs
	6058025904	4"x8"x14"	WEATHERED BUFF DOUBLE ROUNDNOSE	90	30 lbs	2700 lbs
	6058025907	4"x8"x14"	WEATHERED NORMANDY DOUBLE ROUNDNOSE	90	30 lbs	2700 lbs
	6058025917	4"x8"x16"	WEATHERED BUFF DOUBLE ROUNDNOSE	90	32 lbs	2880 lbs
	6058025916	4"x8"x16"	WEATHERED NORMANDY DOUBLE ROUNDNOSE	90	32 lbs	2880 lbs
	6058022290	4"x8"x8"	WEATHERED NORMANDY ROUNDNOSE CORNER	180	17 lbs	3060 lbs

Landscaping Stones



Circle Stones

	Code	Size	Color	Pieces Per Package	Per Piece Weight	Package Weight
	6058026707	Face 9" (W) Back 6"(W) x 7"(D) x 4"(H)	NON WEATHERED BUFF CIRCLE	60	14 lbs	840 lbs
	6058026082	Face 9" (W) Back 6"(W) x 7"(D) x 4"(H)	NON WEATHERED NORMANDY CIRCLE	60	14 lbs	840 lbs
	6058026708	Face 9" (W) Back 6"(W) x 7"(D) x 4"(H)	WEATHERED BUFF CIRCLE	60	14 lbs	840 lbs
	6058026083	Face 9" (W) Back 6"(W) x 7"(D) x 4"(H)	WEATHERED NORMANDY CIRCLE	60	14 lbs	840 lbs

Multi Use Stone

	Code	Size	Color	Pieces Per Package	Per Piece Weight	Package Weight
	6058025783	Face 12"(W), Back 9"(W) x 10"(D) x 4"(H)	NON WEATHERED BUFF MU LDSCP STN	84	33 lbs	2772 lbs
	6058025784	Face 12"(W), Back 9"(W) x 10"(D) x 4"(H)	NON WEATHERED NORMANDY MU LDSCP STN	84	33 lbs	2772 lbs
	6058025781	Face 12"(W), Back 9"(W) x 10"(D) x 4"(H)	WEATHERED BUFF MU LDSCP STN	84	33 lbs	2772 lbs
	6058025786	Face 12"(W), Back 9"(W) x 10"(D) x 4"(H)	WEATHERED NORMANDY MU LDSCP STN	84	33 lbs	2773 lbs







Garden Wall Stone

	Code	Size	Color	Pieces Per Package	Per Piece Weight	Package Weight
	6058061455	4"(H) x 6.5"(D) x 14"(L)	GARDEN WALL STONE GRAY	126	24.2 lbs	3080 lbs
	6058061454	4"(H) x 6.5"(D) x 14"(L)	GARDEN WALL STONE BUFF	126	24.2 lbs	3080 lbs
	6058061456	4"(H) x 6.5"(D) x 14"(L)	GARDEN WALL STONE NORMANDY	126	24.2 lbs	3080 lbs







Versa-Lok Segmental Retaining Wall Block



Standard Units







	Code	Size	Color	Pieces Per Package	Per Piece Weight	Package Weight
	6058004581	6"(H)x16"(L)x12"(D)	NON WEATHERED GRAY	36	84 lbs	3024 lbs
	6058004582	6"(H)x16"(L)x12"(D)	NON WEATHERED BUFF	36	84 lbs	3024 lbs
	6058023946	6"(H)x16"(L)x12"(D)	NON WEATHERED NORMANDY	36	84 lbs	3024 lbs
	6058023525	6"(H)x16"(L)x12"(D)	WEATHERED GRAY	36	84 lbs	3024 lbs
	6058023520	6"(H)x16"(L)x12"(D)	WEATHERED BUFF	36	84 lbs	3024 lbs
	6058023947	6"(H)x16"(L)x12"(D)	WEATHERED NORMANDY	36	84 lbs	3024 lbs

Accent Units



	Code	Size	Color	Pieces Per Package	Per Piece Weight	Package Weight
	6058022981	4"(H)x12"(L)x12"(D)	NON WEATHERED GRAY	84	36 lbs	3024 lbs
	6058022982	4"(H)x12"(L)x12"(D)	NON WEATHERED BUFF	84	36 lbs	3024 lbs
	6058023985	4"(H)x12"(L)x12"(D)	NON WEATHERED NORMANDY	84	36 lbs	3024 lbs
	6058023527	4"(H)x12"(L)x12"(D)	WEATHERED GRAY	84	36 lbs	3024 lbs
	6058023530	4"(H)x12"(L)x12"(D)	WEATHERED BUFF	84	36 lbs	3024 lbs
	6058023986	4"(H)x12"(L)x12"(D)	WEATHERED NORMANDY	84	36 lbs	3024 lbs

Versa-Lok Segmental Retaining Wall Block cont.

Cobble Units

	Code	Size	Color	Pieces Per Package	Per Piece Weight	Package Weight
	6058023167	6"(H)x8"(L)x12"(D)	NON WEATHERED GRAY	72	40 lbs	2880 lbs
	6058022296	6"(H)x8"(L)x12"(D)	NON WEATHERED BUFF	72	40 lbs	2880 lbs
	6058025736	6"(H)x8"(L)x12"(D)	NON WEATHERED NORMANDY	72	40 lbs	2880 lbs
	6058023528	6"(H)x8"(L)x12"(D)	WEATHERED GRAY	72	40 lbs	2880 lbs
	6058023529	6"(H)x8"(L)x12"(D)	WEATHERED BUFF	72	40 lbs	2880 lbs
	6058025735	6"(H)x8"(L)x12"(D)	WEATHERED NORMANDY	72	40 lbs	2880 lbs

Square Foot Units

	Code	Size	Color	Pieces Per Package	Per Piece Weight	Package Weight
	6058004587	8"(H)x18"(L)x12"(D)	GRAY	36	90 lbs	3240 lbs
	6058004588	8"(H)x18"(L)x12"(D)	BUFF	36	90 lbs	3240 lbs
	6058026476	8"(H)x18"(L)x12"(D)	NORMANDY	36	90 lbs	3240 lbs

6099000693 **VERSA-LOK PINS TUFF PINS**

6099021659 **VERSA-LOK PINS TUFF PINS SNAP OFF FOR MOSAIC ONLY**

Rockwood Premier 8









Code	Size	Color	Pieces Per Package	Per Piece Weight	Package Weight
6058031756	8"(H)x18"(L)x12"(D)	ROCKWOOD PREMIER 8 SRW GRAY	48	56 lbs	2688 lbs
6058031755	8"(H)x18"(L)x12"(D)	ROCKWOOD PREMIER 8 SRW BUFF	48	56 lbs	2688lbs
6058031757	8"(H)x18"(L)x12"(D)	ROCKWOOD PREMIER 8 SRW NORMANDY	48	56 lbs	2688 lbs

Rockwood Premier 6 Smooth





Code	Size	Color	Pieces Per Package	Per Piece Weight	Package Weight
6058050128	6"(H)x18"(L)x12"(D)	ROCKWOOD PREMIER 6 SRW SLATE	60	43 lbs	2605 lbs
6058050127	6"(H)x18"(L)x12"(D)	ROCKWOOD PREMIER 6 SRW NORMANDY	60	43 lbs	2605lbs
6058063430	3.5"(H)x16"(L)x12"(D)	ROCKWOOD PREMIER 6 CAP SLATE	60	50 lbs	3025 lbs
6058063429	3.5"(H)x16"(L)x12"(D)	ROCKWOOD PREMIER 6 CAP NORMANDY	60	50 lbs	3025 lbs

Universal Cap Units



	Code	Size	Color	Pieces Per Package	Per Piece Weight	Package Weight
	6058061663	4"(H)x18"(L)x12"(D)	UNIVERSAL STRAIGHT-SIDED CAP GRAY	48	64 lbs	3072 lbs
	6058061662	4"(H)x18"(L)x12"(D)	UNIVERSAL STRAIGHT-SIDED CAP BUFF	48	64 lbs	3072 lbs
	6058061664	4"(H)x18"(L)x12"(D)	UNIVERSAL STRAIGHT-SIDED CAP NORMANDY	48	64 lbs	3072 lbs
	6058061672	4"(H)x18"(L)x12"(D)	UNIVERSAL STRAIGHT-SIDED CAP GRAY WEATHERED	48	64 lbs	3072 lbs
	6058061671	4"(H)x18"(L)x12"(D)	UNIVERSAL STRAIGHT-SIDED CAP BUFF WEATHERED	48	64 lbs	3072 lbs
	6058061673	4"(H)x18"(L)x12"(D)	UNIVERSAL STRAIGHT-SIDED CAP NORMANDY WEATHERED	48	64 lbs	3072 lbs

Universal SQ.FT. Corner Units

Universal Cap Units will work with any General Shale SRW system.

	Code	Size	Color	Pieces Per Package	Per Piece Weight	Package Weight
	6058027132	8"(H)x18"(L)x9"(D)	GRAY CORNER UNIT	30	90 lbs	3240 lbs
	6058027130	8"(H)x18"(L)x9"(D)	BUFF CORNER UNIT	30	90 lbs	3240 lbs
	6058027129	8"(H)x18"(L)x9"(D)	NORMANDY CORNER UNIT	30	90 lbs	3240 lbs

Retaining Wall Accessories

	Code	Size	Product	Pieces Per Package	Package Coverage
	6099038064	6.5'x330'	GRIDMAXX GEOGRID GMX 390	1 roll	240 SQ.YDS.
	6099037555	23.4"(H)x15.3"(W) x30.6"(D)	SLEEVE-IT FENCE POST ANCHOR	1 each	1 each
	6099036981	7-3/4"(H)x14"(D)x 3-3/4"(W)	WALL DRAIN PRO	1 each	1 each

Ground Covers



Code	Product	Weight
6099023608	ONE TON BAGGED BRICK CHIPS	2000 lbs
6099023634	ONE TON BAGGED SAND	3000 lbs

Fire Brick



Code	Size	Product	Pieces Per Cube	Per Piece Weight	Package Weight
6099010268	1 1/2"(H)x4"(D) x9"(L)	Split Fire Brick	850	3.5 lbs	3020 lbs
6099004449	2 1/4"(H)x4"(D) x9"(L)	Fireplace Brick	616	5.8 lbs	3620 lbs

Outdoor Living Kits

Code	Product	Description	Weight
6058026017	COL-100	THE PALDAN GARDEN COLUMN	1575 lbs
6058027482	COL-100 UPGRD	THE PALDAN GARDEN COLUMN UPGRADE	620 lbs
6058026561	FPL-100	THE SERENITY 100 FIREPLACE	5620 lbs
6058022276	FPL-100 UPGRD	THE SERENITY 100 MULTI-USE SURROUND UPGRADE	2485 lbs
6058030007	FPL-150	THE SERENITY 150 FIREPLACE	8100 lbs
6058030586	FPL-175	THE SERENITY 175 FIREPLACE	9800 lbs
6058026560	FPL-200	THE SERENITY 200 FIREPLACE	7540 lbs
6058030504	WBX-150	WBX-150 NORMANDY	2400 lbs
6058027188	WBX-200	THE STACKER WOOD BOX	2485 lbs
6058060136	FPR-75	ENTERTAINER FIREPIT NORMANDY	850 lbs
6058031518	FPS-75	SQUARE FIREPIT NORMANDY	1300 lbs



THE PALDAN GARDEN COLUMN



THE PALDAN GARDEN COLUMN UPGRADE



THE SERENITY 100 FIREPLACE



THE SERENITY 100 MULTI-USE SURROUND UPGRADE



THE SERENITY 150 FIREPLACE



THE SERENITY 175 FIREPLACE



THE SERENITY 200 FIREPLACE



WBX-150 NORMANDY



THE STACKER WOOD BOX



ENTERTAINER FIREPIT NORMANDY



SQUARE FIREPIT NORMANDY

FIREPLACES & ACCESSORIES



Standard Fireplaces



Description	Code	Weight
STANDARD 36	6099048701	1,255 lbs
STANDARD 42	6099048700	1,374 lbs
STANDARD 46	6099048699	1,499 lbs

Magnum Fireplaces



Description	Code	Weight
MAGNUM 28	6099029447	1,088 lbs
MAGNUM 36	6099048702	1,349 lbs
MAGNUM 42	6099048698	1,470 lbs
MAGNUM 48	6099048697	1,645 lbs
MAGNUM 60	6099029448	2,394 lbs

MAGNUM 72, 84, 96, 108, and 120 available by special order. Contact your sales representative for more details.

Magnum Accessories



Description	Code	Weight
EARTH CORE ADHESIVE (5 gallons)	6099048725	50 lbs







Description	Code	Weight
REFRACTORY MORTAR	6099048724	50 lbs

CHIMNEYS

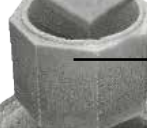
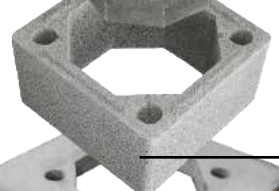

DM54 – Dual Module Chimney System

	Description	Code	Weight
	CROWN CAP	6099048704	110 lbs
	INNER LINER	6099029425	45 lbs
	OUTER CASING	6099029424	90 lbs
	BRICK LEDGE	6099048703	110 lbs
	6" STARTER FLUE	6099029423	19 lbs
	OFFSET BLOCK (Moves 3" or 30°)	6099029427	110 lbs