

Design with freedom.

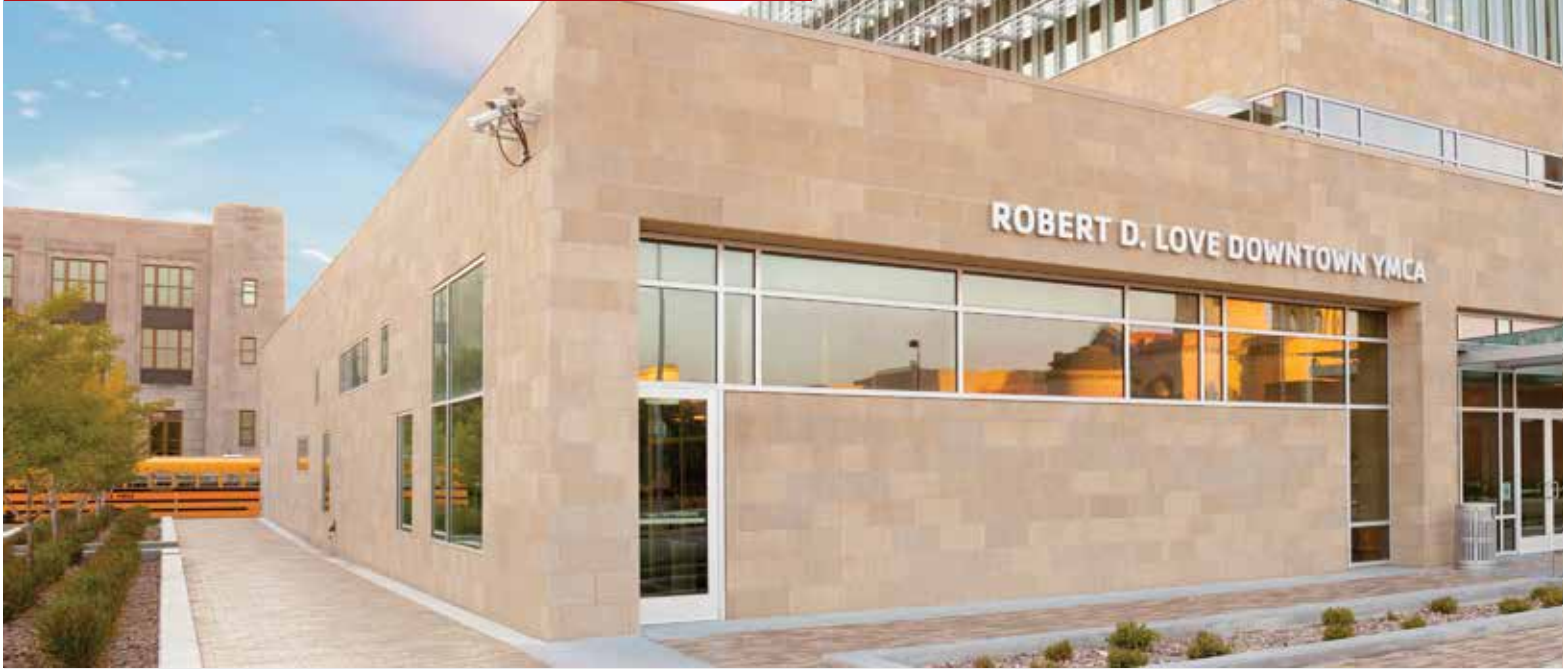

The Canadian Renaissance® Collection

Why Renaissance®?



Robert D. Love Downtown YMCA - Wichita, KS | Schaefer Johnson Cox Frey Architecture | Sandrift Sandblasted

Arriscraft Renaissance® Masonry Units offer architects, builders and property owners a premium stone with exceptional performance, beauty and flexibility. Our unique Natural Process technology mimics how stone is created in the earth – yielding cement-free stone products with the aesthetic, strength and durability benefits of quarried stone, plus cost effective installation.

Renaissance® units are offered in standard sizes and colours, yet offer tremendous flexibility through custom colours, blends, shapes and sizes - in rocked or sandblasted finishes. Discover the unparalleled beauty and design opportunities of Renaissance® Masonry Units, backed by an industry-unique lifetime product warranty.

Standard Masonry Units

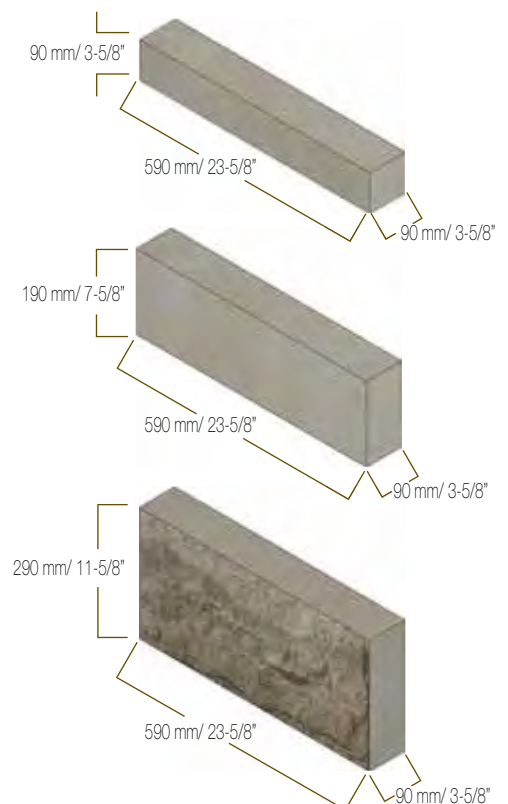



“ Arriscraft stone brings timeless elegance to our modern design. The best products, the best service, the best results.

MILAN MALINOVIC, PRINCIPAL
Design Cooperative, LLC



NATURAL EDGE®

Our Natural Process technology replicates how stone is formed in the earth and creates products with the aesthetics and durability of quarried stone, plus the benefits of standard installation and unlimited supply.



SELECTION

Our comprehensive product range includes: the classic Renaissance® stone, a robust Building Stone collection, three versatile thin-clad options, various brick styles (including our long, contemporary option), Adair® limestone, and a full offering of cast accessories.



SOLUTIONS

We lead the industry in premier product support, including an extensive technical library, complimentary Masonry Envelope Review services, personal technical support, and renowned custom colour and blend development. Our on-site technical services can provide historical matching, unique colours and custom blends, as required.



INNOVATION

Product innovation at Arriscraft continues to meet market demands for modern stone designs and lightweight, thin stone solutions, as well as matching processes to replicate historical stone as quarries close after decades of use. We also continuously improve our manufacturing process to lead the industry in green and sustainability initiatives.



EDUCATION

We educate daily through our technical support, AIA credit courses, and an ever-broadening information base. Our website offers high-res colour sheets, data sheets, seamless texture images, a Building Stone Calculator, plus our growing blog of articles and tips. For decades we've provided complimentary mason training and student tours, and sponsored the University of Waterloo Architecture Lecture Series.

Colour Selection



Rappahannock River Hall, CNU | Newport News, VA | Glave & Holmes Architecture | Wheat Rocked and Sandblasted

Renaissance® Masonry Units are available in a stunning range of natural standard colours. Arriscraft offers custom colour development and also allows customers to create custom blends using different standard colours. With so much creative flexibility, Arriscraft can bring any design to life.

Because all Arriscraft products are manufactured to have through-body colour, units can be cut, chiseled and dressed on-site. In addition, designers can order custom shapes and sizes to create truly unique projects.



Birchbark

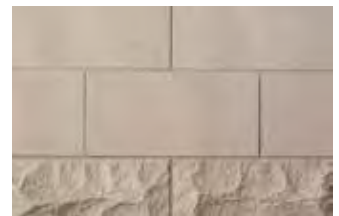

Nutmeg



Private Residence | Nutmeg Sandblasted

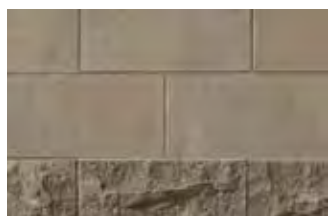

Barnboard

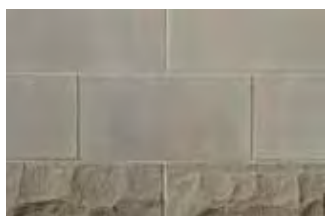

Carbon

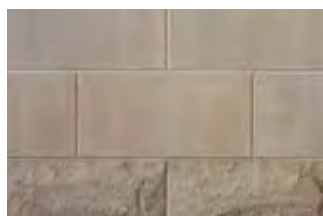

Driftwood

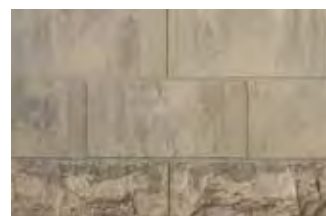

Ironstone



Olive

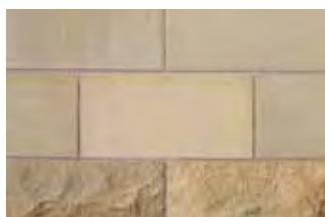

Sandrift



Wheat

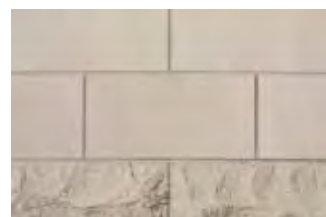

White

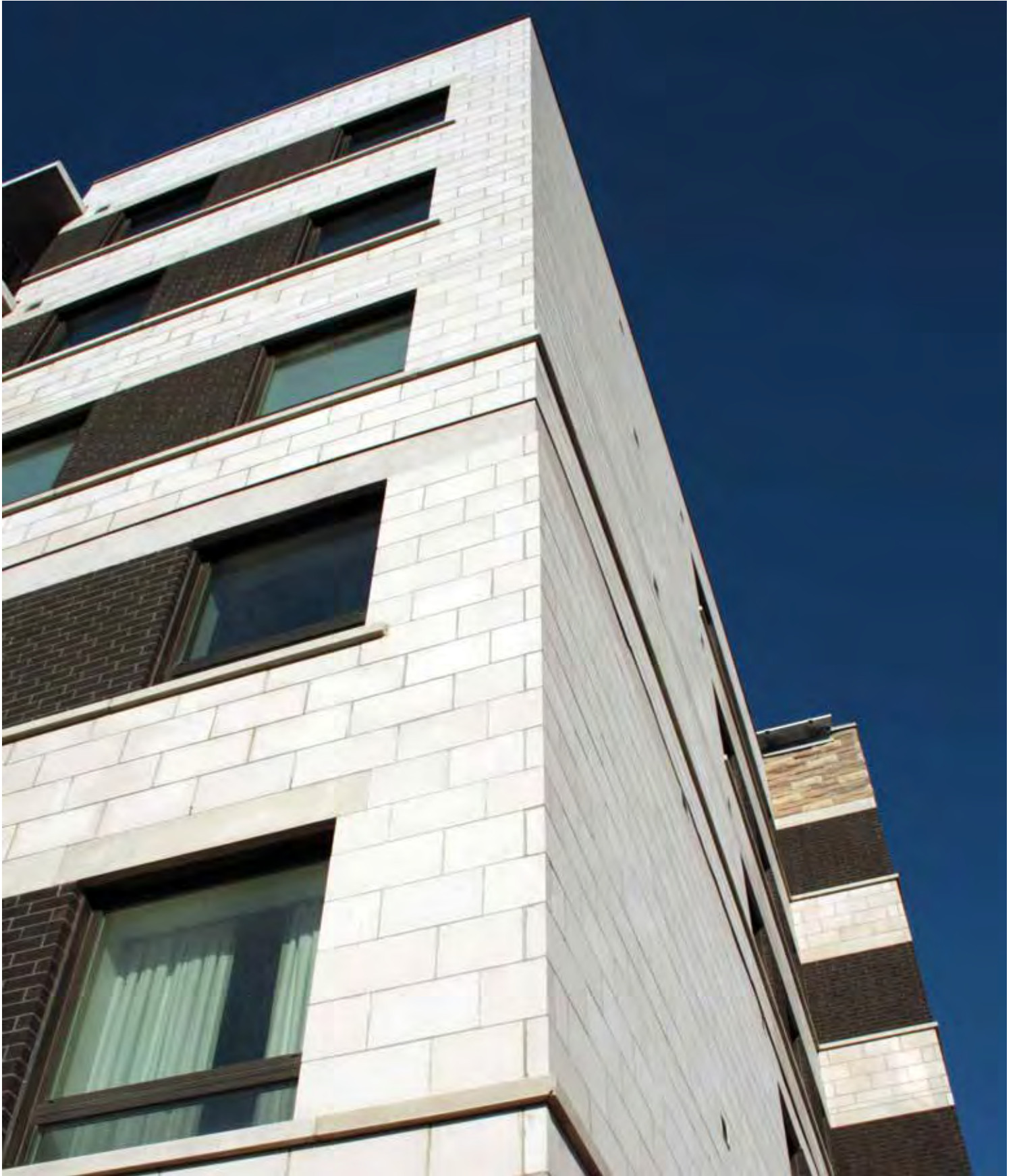

Green Life Building 3 - Milton, ON | LMA Architects | White Sandblasted



“ The wide range of shapes, colours and textures available in Arriscraft products challenges the architects’ creativity and provides masonry design opportunities that are both affordable and aesthetically pleasing.

CHUCK BOOS
Kaestle, Boos Associates, Inc.

La Vista Condominiums - Vancouver, BC | Hudson West Development Group | Wheat Sandblasted



Private Residence | Driftwood Sandblasted



388 Prince of Wales Dr. - Mississauga, ON | Kirkor Architects | Nutmeg Sandblasted



Southwest Centre for Forensic Mental Health Care - St. Thomas, ON | Tillmann Ruth Robinson | Renaissance® Nutmeg Sandblasted and Rocked

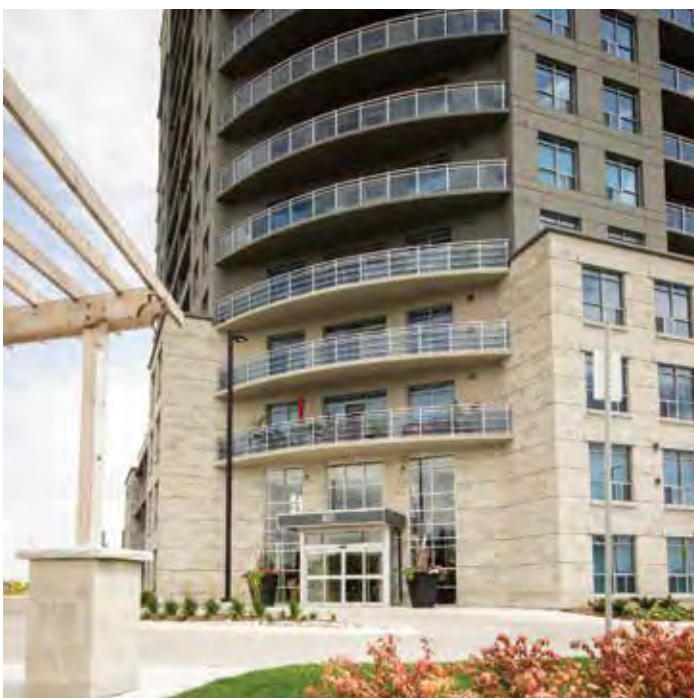

Hyde Park Apartments - London, ON | Oak Properties | Ironstone Sandblasted

“ It’s reached the point where one of the first things I ask myself when designing a project is ‘Where can I put the (Arriscraft) Renaissance® stone?’ It’s such a high quality product that its presence in the project alone takes the user to another level.

L. MARK LOUDERMILK
Cline Design Associates

Versatile Design and Installation

Like any artist's raw material, Renaissance® puts design into your hands. Enjoy absolute flexibility with a stone product that you can shape, colour, size, and install as you like. Here are a few examples of the creative options with Renaissance®.

Custom Colours

In addition to an array of standard colours, we can provide custom blends or entirely custom colours. This flexibility allows you to co-ordinate seamlessly with other structures and even match historical projects.



1. & 2. Colours were created to the architect's specification.

Installation Options

Standardized sizes allow for unique bond patterns, such as repeating or vertical installations, as well as traditional bond patterns.

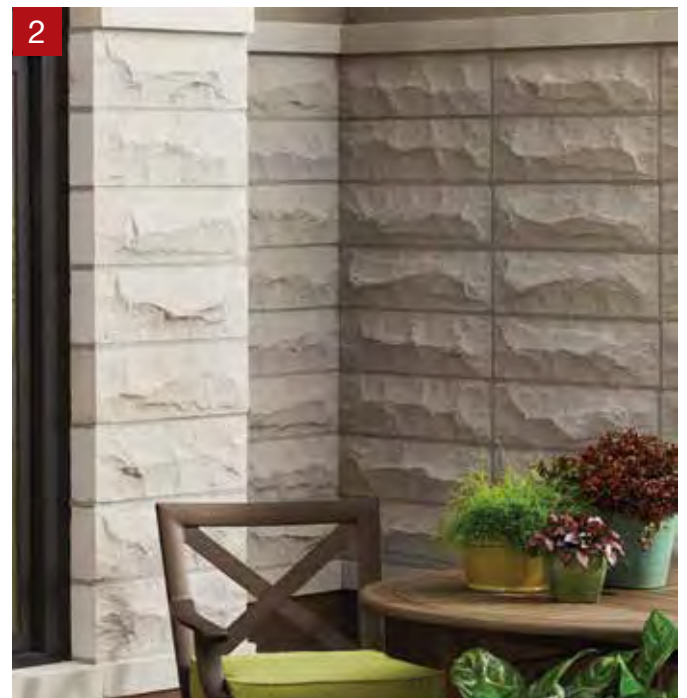

1. Stone installed in a vertical quarter bond pattern | 2. Stone installed in a stack bond pattern

Custom Shapes

The through-body colour and texture of Renaissance® stone makes shaping and detailing possible and is an ideal way to make designs absolutely unique. Custom shapes can be created on-site by the mason or on spec at our manufacturing facility.



1. Custom Arch and Post units, Bullnose | 2. Bullnose and custom detail | 3. Chamfers and Sills



Middlesex-London Paramedic Service - London, ON | Tillman Ruth Robinson | Carbon

About Arriscraft

Arriscraft manufactures a vast range of premium stone for commercial and residential projects, including full-bed Building Stone, Renaissance® Masonry Units, thin-clad adhered and clipped veneers, Adair® Limestone, and cast accessories.

Cambridge, Ontario Plant
875 Speedsville Road
Cambridge, Ontario, Canada
N3H 4S8

Toll Free: 800-265-8123
Email: solutions@arriscraft.com

Fort Valley, Georgia Plant
6054 Zenith Mill Road, Arriscraft Lane
Fort Valley, Georgia, USA
31030

Phone: 478-827-1896
Fax: 478-827-1897

IMPORTANT NOTES

Colours and textures have been reproduced as closely as the printing process allows. Final selection should be made from actual samples.

Renaissance® Masonry Units' compressive strength, durability and dimensional tolerances are within the range of those of quality limestone (ASTM C568) and sandstone products (ASTM C616).

Renaissance® Masonry Units meet the severe-weathering requirements of ASTM C73 for Calcium Silicate units.

Renaissance® Masonry Units must be installed using industry recommended materials and techniques and conform to all related building code requirements. All masonry products are intended for above-grade installations. Proper care, installation and cleaning are required for warranty validation. Please refer to Arriscraft-DATA Renaissance® Masonry Units and Arriscraft-CARE Storage and Handling at: www.arriscraft.com



Arriscraft is the stone products group of General Shale, the North American subsidiary of Wienerberger AG and a leading manufacturer of brick, one of the world's oldest green building materials.

ON THE COVER

Project: Ellington Apartments - Markham, ON
Architect: LMA Architects
Colour: Nutmeg Custom Dressed Finish

